

AcuDC 200 Series Power Meter
User's Manual



Copyright 2012 © V1.22 Accuenergy Tech. Ltd.

This manual may not be altered or reproduced in whole or in part by any means without the expressed written consent of Accuenergy.

The information contained in this document is believed to be accurate at the time of publication, however, Accuenergy assumes no responsibility for any errors which may appear here and reserves the right to make changes without notice. Please ask the local representative for latest product specifications before ordering.

[Document #1501E2122 Revision Date: Jul., 2012]

Please read this manual carefully before doing installation, operation and maintenance of AcuDC 200 series DC meter.



Safety Alert Symbol: Carries information about circumstances which if not considered may result in injury or death.



Electric Shock Symbol: Carries information about procedures which must be followed to reduce the risk of electric shock and danger to personal health.

DANGEROUS

Potential Danger Symbol: Carries information about nearby hazards. Safety operation procedures must be followed to avoid personal injuries.



Alarm Symbol: Carries information about user operation procedures which if not follow may cause malfunction of the meter and may result in injury.

Installation and maintenance of the AcuDC 200 series DC meter should only be performed by qualified, competent personnel who receive appropriate training and should have experience with high voltage and current devices.

Accuenergy shall not be responsible or liable for any damages cause by improper meter installation and or operation.

Content

Chapter 1 Introduction	1
1.1 AcuDC 200 Overview.....	2
1.2 Application Area.....	3
1.3 AcuDC 200 Series.....	4
Chapter 2 Installation	5
2.1 Appearance and Dimensions.....	6
2.2 Installation Method.....	8
2.3 AcuDC 200 Wiring Diagram.....	14
2.3.1 Auxiliary Power Requirement.....	15
2.3.2 Voltage and Current Input.....	17
2.3.3 I/O Setting.....	22
2.3.4 Communication.....	28
Chapter 3 Basic Operation and Setup	33
3.1 Display Panel and Keys.....	34
3.2 Real-Time Metering Mode	36
3.3 Parameter Setting Mode.....	37

Chapter 4 Communication	47
4.1 Modbus Protocol Introduction.....	48
4.2 Communication Format.....	52
4.3 AcuDC 200 Address Table.....	60
Appendix	65
Appendix A Technical Data and Specification.....	66
Appendix B Ordering Information.....	70
Appendix C Hall Effect Sensor Specifications.....	72
Appendix D Revision Information.....	76

Starting!

Congratulations!

You have purchased an advanced, versatile, multifunction power meter. This meter can work as a remote terminal unit (RTU) that contributes to your system's stability and reliability by providing real-time power quality monitoring and analysis.

When you open the package, you will find the following items.

- | | |
|-------------------------------|---|
| 1. AcuDC 200 series meter | 1 |
| 2. Removable 14 pin terminal | 1 |
| 3. Installation clips | 2 |
| 4. User's manual | 1 |
| 5. Maintenance guarantee card | 1 |

Please read this manual carefully before operating or installing the AcuDC 200 meter to avoid unnecessary trouble. You can read part of this manual depends on how you use the AcuDC 200 meter.

Chapter 1 Basic function, specification and application area of AcuDC 200 meter.

- Chapter 2 Installation and wiring details of AcuDC 200 meter.
- Chapter 3 Real-time metering data display and parameter setting method of AcuDC 200 meter.
- Chapter 4 Communication protocol format and address table of AcuDC 200.
- Appendix Technical data and specifications of AcuDC 200 and ordering information.

Chapter 1 Introduction

1.1 AcuDC 200 Overview

1.2 Application Area

1.3 AcuDC 200 Series

1.1 AcuDC 200 Overview

Powerful Multifunction Power Meter

AcuDC 200 Series multifunction intelligent power meter can measure DC voltage and current with high accuracy. Analog output can be used in DCS system or industry control system. Large character LCD display with backlight provides clear real-time monitoring data readout. This DC meter is designed to meet the requirement for DC power measurement and monitoring.

Small Size and Easy Installation

With the size of DIN96 ×48 and 71mm depth after mounting, the AcuDC 200 meter can be installed in a small gear. Fixing clips are used for easy installation and removal.

Ease of Use

AcuDC 200 utilizes a large character LCD display for clear electrical parameters readout. All setting parameters are accessible by using front panel keys or

communication port (if equipped). Setting parameters are protected in EEPROM, which will maintain its content after the meter is powered off. With the backlight of the LCD, the display can be easily read under dim environment. The backlight "ON" time duration is programmable.

High safety, high reliability

AcuDC 200 meter was designed according to industry standards. The meter receives IEC and UL emission and immunity compliances and is able to operate reliably under high power disturbance condition.

1.2 Application Area

Solar and Wind Energy Systems

Industry Control Systems

DC Energy Management Systems

Large UPS Systems

1.3 AcuDC 200 Series

This manual is based on AcuDC 223. Other models may not contain certain functions, please refer to the following table for details:

Function	Parameter	AcuDC 221	AcuDC 222	AcuDC 223	AcuDC 211	AcuDC 212	AcuDC 213
Measuring	Voltage (V)	●		●	●		●
	Current (I)		●	●		●	●
	Power (P)			●			●
	Energy(E)			●			●
I/O options	DI	⊙	⊙	⊙			
	RO	⊙	⊙	⊙			
AO	4~20mA /0~5V	⊙	⊙	⊙	⊙	⊙	⊙
Alarm		⊙	⊙	⊙			
Communication	RS485 MODBUS	⊙	⊙	⊙			
LCD display		●	●	●	●	●	●

● function ⊙ option Blank NA

Chapter 2 Installation

2.1 Appearance and Dimensions

2.2 Installation method

2.3 AcuDC 200 Wiring Diagram

2.3.1 Auxiliary Power Requirement

2.3.2 Voltage and Current Input

2.3.3 I/O Setting

2.3.4 Communication

2.1 Appearance and Dimensions

The installation method is introduced in this chapter. Please read this chapter carefully before installation work.

Appearance

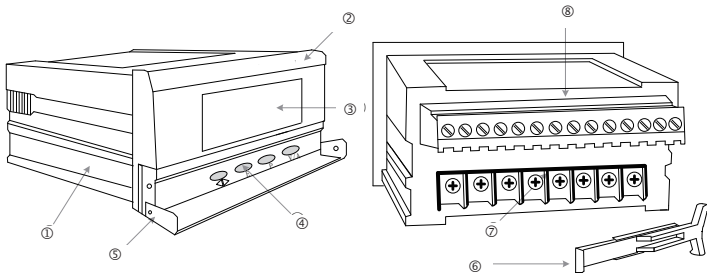

Figure 2.1 Appearance of AcuDC 200 meter

Table2.1 Part name of AcuDC 200 meter

Part Name	Description
1. Enclosure	The AcuDC 200 meter enclosure is made of high strength anticombustion engineering plastic
2. Front Casing	Visible portion (for display and control) after mounting onto a panel
3. LCD Display	Large bright blue backlight LCD display
4. Key	Four keys are used to select display and to set parameters of the meter
5. Key Cover	Close the cover to avoid wrong key operation
6. Installation Clip	Use for locating the meter to the panel
7. Input Terminals	Auxiliary power, voltage and current input
8. Extend Wiring Terminals	Communication: DI,RO,AO

Dimension (mm/inch)

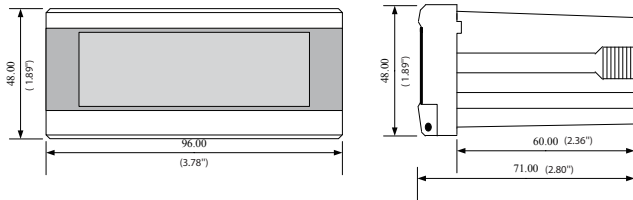

Figure 2.2 Dimension of AcuDC 200

2.2 Installation Method

Environment

Before installation, please make sure that the environment meets the following conditions.

1. Temperature

AcuDC 200 meter's working temperature range is from -25°C to 70°C . Operating the meter beyond this range may result in abnormal performance or damaging meter permanently.

AcuDC 200 meter's storage range is from -40°C to 85°C .

2. Humidity

AcuDC 200 meter's working humidity range is from 0 to 95% non-condensing.

3. Position

AcuDC 200 meter should be installed in a dry and dust free environment. Avoid exposing meter to excessive heat, radiation and high electrical noise source.

Installation Steps

AcuDC 200 Series meter is typically installed on the panel of switch gear.

1. Cut a rectangular hole on the panel of the switch gear.

The cutting size is as fig 2.3, Unit: mm (inch).

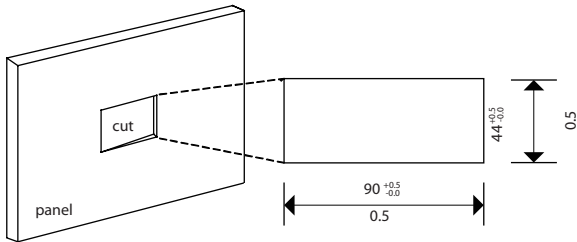

Fig 2.3 Panel Cutting

2. Remove installation clips from the meter and insert the meter into the rectangular hole from the front side.

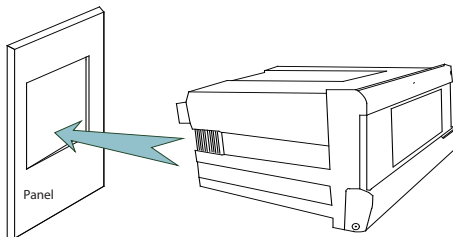

Fig 2.4 Put the meter into the rectangular hole

3. Install clips back to the meter from the backside and push the clip tightly so that the meter is fixed on the panel.

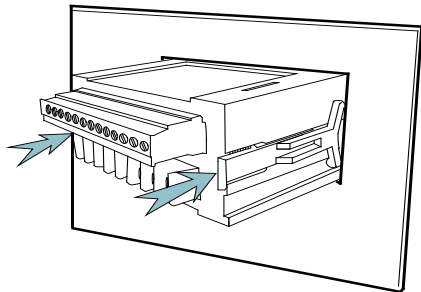

Fig 2.5 Use the clips to fix the meter on the panel

Space required for Installation

There should be enough spacing for users to run wires to the meter, install and remove wiring terminal connectors, and operate the meter without interfering or damaging nearby equipment.

Recommended minimum space around the meter is shown in Table 2.2 and Fig 2.6.

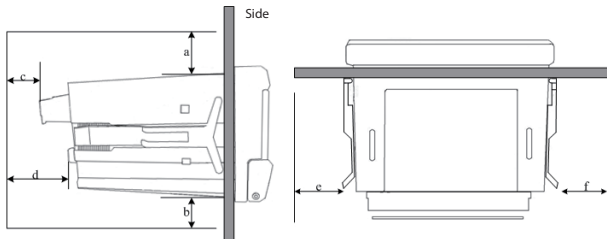

Fig 2.6 Space around the meter

Table 2.2 Minimum Space

temperature	Minimum distance(mm)					
	a	b	c	d	e	f
<50°C	25	25	38	64	25	25
≥50°C	38	38	51	76	38	38

2.3 AcuDC 200 Wiring Diagram

There are two terminal strips at the back of AcuDC 200.

Top diagram: I/O ports and Communication terminals.

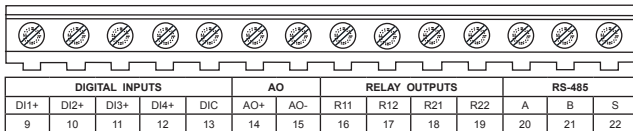

Bottom diagram: Power, Voltage Input and Current Input ports.

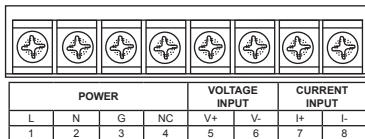

Note: NC means no connection

Fig 2.7 Wiring terminals

Safety Earth Connection

Before setting up the meter's wiring, please make sure that the switch gear has an earth ground terminal. Connect both the meter's and the switch gear's ground terminal together. The following ground terminal symbol is used in this user's manual.



2.3.1 Auxiliary Power Requirement



DANGEROUS

Only the qualified personnel could do the wire connection work. Make sure the power supply is cut off and all the wires are electroless. Failure to observe it may result in severe injury.

There are 2 options for the Auxiliary Power Supply for the AcuDC 200 series meter:

1. Standard: 100 - 240Vac (50/60Hz) or 100-300Vdc
2. Low Voltage DC Option: 20-60Vdc

The 2 options must be chosen according to the application. Please see the ordering information appendix for further details.

The first option is mainly used under illumination power conditions, the other is used under accumulator battery conditions. Typical power consumption of the

meter is less than 2W. A regulator or a UPS should be used when the power supply undulates too much. Pin numbers for the auxiliary power are 1, 2 and 3 (L, N, G). A switch or circuit-breaker shall be included in the building installation, in close proximity to the equipment, and within easy reach of the operator. It shall be marked as the disconnecting device for the equipment.



Note

Make sure the voltage of power supply is the same as what the meter needed for its auxiliary power.



Note

Make sure the auxiliary power terminal G is connected to the earth ground terminal of the switch gear.

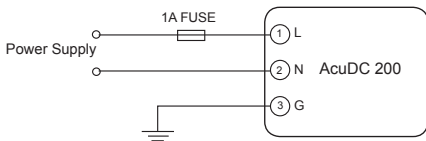

Fig 2.8 power supply

A fuse (typical 1A/250Vac) should be used in auxiliary power supply loop. No.3 terminal must be connected to the ground terminal of switch gear.

An isolated transformer or EMI filter should be used in the auxiliary power supply loop if there is power quality problem in the power supply.

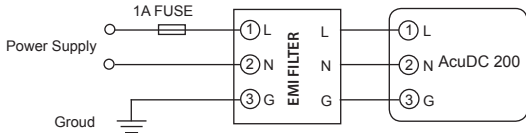

Fig 2.9 power supply under EMI filter

Choice of power supply wire could be AWG22-16 or $0.6\text{-}1.3\text{mm}^2$.

2.3.2 Voltage and Current Input

Voltage is directly input into the meter or via hall effect sensor. The wiring diagram is as follows:

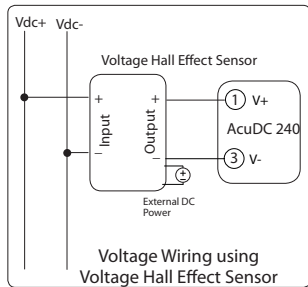
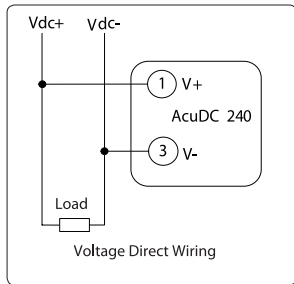

Fig 2.10 Voltage wiring

There are three wiring configurations for current:

- 1) Direct Input (shown in Fig 2.11);
- 2) Current Shunt option (shown in Fig. 2.12);
- 3) Hall Effect Sensor option (shown in Fig 2.13)

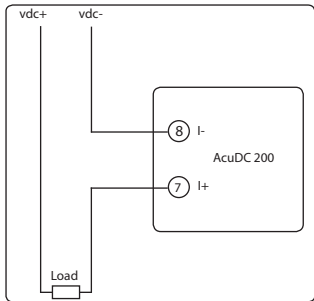

Fig 2.11 Current direct input wiring

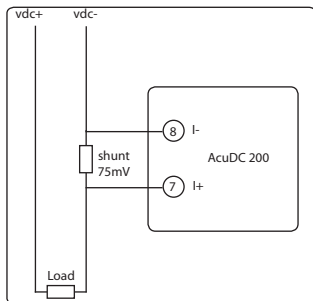

Fig 2.12 Current input wiring with Shunt

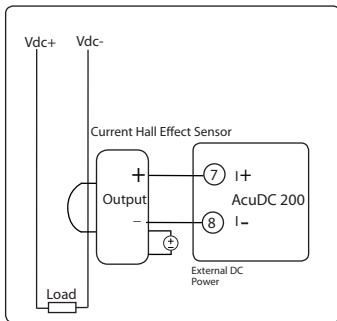

Fig 2.13 Current input wiring with Hall Effect Sensor

Wiring diagrams shown in Fig 2.14, 2.15 and 2.16 represent different scenarios in which both voltage input and different current input options are used.

Fig 2.17 is voltage and current input with voltage and current Hall Effect Sensors.

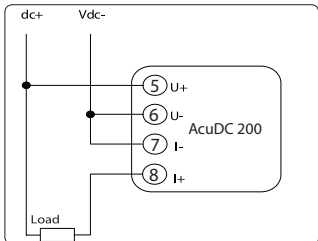

Fig 2.14 Voltage and Current direct input

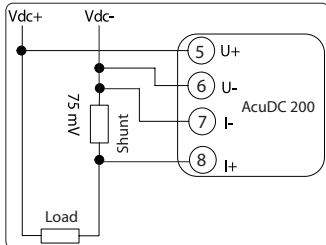

Fig 2.15 Voltage and Current input with Shunt

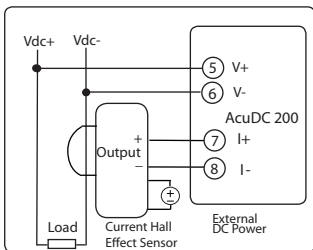

Fig 2.16 Voltage and Current input with Hall Effect Sensor

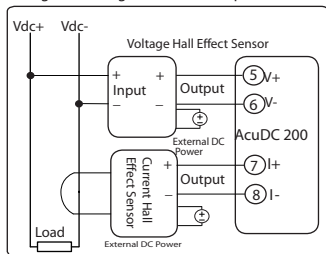

Fig 2.17 Voltage and Current input with Hall Effect Sensors

Current direct input wiring is used for current smaller than 10A, the current signal wire choose AWG 15~16 or $1.5\sim 2.5\text{ mm}^2$ or greater cross section. Current wiring using shunt method is used for current larger than 10A, the current signal wire choose AWG 15~16 or $1.5\sim 2.5\text{ mm}^2$ or the same resistance rate wire.

2.3.3 I/O Setting

Digital Input

External power supply is required for the 4 Digital Inputs (if equipped) of the AcuDC 220 Series. Input terminals are DI1+(9), DI2+(10), DI3+(11), DI4+(12), DIC(13). The circuit drawing of the digital input is simplified as fig 2.17.

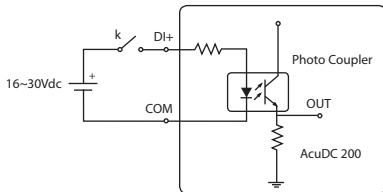

Fig 2.18 Simplified DI input circuit

The external power supply voltage range for DI is from 16Vdc to 30Vdc. In order to compensate for interference, voltage of the external power supply may be higher when the DI's load is located at a distance; however, the maximum current for the circuit must not be over 20mA. Wires with cross-section of $0.6\sim 1.5\text{mm}^2$ (AWG 16~22) should be used for DI.

Relay Output

Two relay outputs (RO), R11,R12 (terminal 16, 17) and R21, R22 (terminal 18,19), can be added to the meter as options.

ROs can be used as remote control electric switches in power systems. Relay type is mechanical Form A contact with 3A/250V or 3A/30Vdc. A mediate relay is recommended in the output circuit as in Fig 2.18.

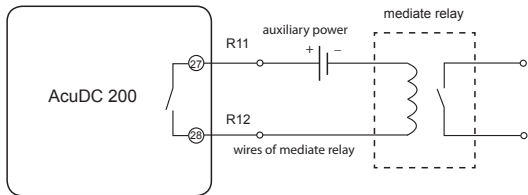

Fig 2.19 Relay Output

The two relays in AcuDC 200 Series can be used to control field switches or other devices. The maximum mechanical response time for the relay is 3ms. Three output modes are available: latching, momentary and alarming. For latching mode, two output status are available: "ON" and "OFF". For momentary mode, output of the relay changes from "OFF" to "ON" for a time interval of "Ton" then goes back to "OFF". "Ton" can be set from 30~5000ms. Output mode and pulse width can only be set through communication. The alarming mode will be discussed in detail in the following chapter under the "alarming" section. The wire of relay output should be chosen between AWG22 (0.5mm²)~AWG16 (1.5mm²)

Analog Output

One analog output (AO) channel can be added to the AcuDC 200 meter as an option. Two types of AO signals are available: 4-20mA or 0~5V. Each meter can only support one type of output (either 4~20mA option or 0~5V option). Please specify your analog output requirement before ordering.

Analog output can track voltage, current and power. The output range is fixed(4~20mA or 0~5V),but the input range can be set due to different applications. Setting procedure is as follows:

Analog output settings can be modified by pressing the front panel keys on all AcuDC 200 Series models. In addition to front panel key pressing, AcuDC 220 Series' setting can be modified using RS485 communication.

1. Select track object: voltage, current or power.
2. Set tracking for the upper and lower limit. Maximum upper limit values for voltage, current and power are 600V, 9999A, 6000kW respectively. The upper limit must be less than the maximum upper limit value and greater than the lower limit

value. The lower limit must be equal to or greater than 0. Appropriate upper and lower limit settings help to increase tracking accuracy and efficiency.

3. The relationship among AO output(out), upper limit(U) and lower limit(L) and measuring value(M) is as follows:

1): Voltage output option for AO: $out = [(M-L)/(U-L)] * 5V$

2): Current output option for AO: $out = 4 + [(M-L)/(U-L)] * 16mA$

Two examples will be used to demonstrate the above two relationships.

AO tracking object and its setting is as follows:

Table 2.3 Tracking object and its Setting number

Setting number	Tracking object
0	Voltage
1	Current
2	Power

1. Example 1: Voltage output option for AO

Set AO to track voltage, upper limit is 600V, lower limit is 0, when the measuring value is 300V, the AO output should be:

$$\text{out} = [(M-L)/(U-L)] * 5V = [(300-0)/(600-0)] * 5V = 2.5V.$$

2. Example 2: Current output option for AO

Set AO to track power, upper limit is 10kW, lower limit is 4kW, when the measuring value is 6kW, the AO output should be:

$$\text{out} = 4 + [(M-L)/(U-L)] * 16mA = 4 + [(300-0)/(600-0)] * 16mA = 9.333mA.$$

Note:

1. Upper limit must be greater than lower limit.
2. If measuring value is less than the lower limit, the output will be 0V/4mA. If the measuring value is greater than the upper limit, the output will be 5 V/20mA.

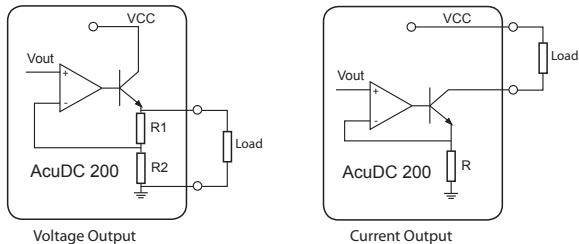

Fig 2.20 Analog Output

Output Capability:

4~20mA, Max Load Resistance 500 Ohm; 0~5 V, Max Output Current 20mA.

2.3.4 Communication

AcuDC 200 series uses RS485 serial communication and the Modbus-RTU protocol. The terminals of communication are A, B, and S (20, 21, 22). A is differential signal +, B is differential signal - and S is connected to shield of twisted pair cable. Up to 32

devices can be connected on a RS485 bus. Use good quality shielded twisted pair cable, AWG22 (0.5mm^2) or larger. The overall length of the RS485 cable connecting all devices cannot exceed 1200m (4000ft). AcuDC 200 is used as a slave device of master like PC, PLC, data collector or RTU. If the master does not have an RS485 communication port, a converter (such as a RS232/RS485 or a USB/RS485 converter) will be required.

Typical RS485 network topologies include line, circle and star (wye).

1. Line

AcuDC 200 meters are connected one by one (daisy chain format) from the master in the RS485 net as in fig 2.20.

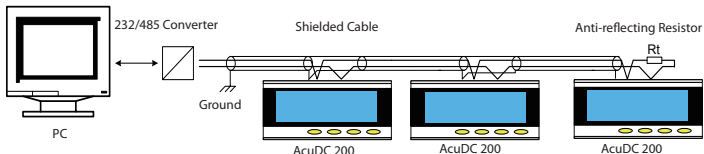

Fig 2.21 Line mode

As shown in Fig 2.20, an anti signal reflecting resistor (typical value 120~300 ohm /0.25W) is added to the end of the circuit beside the last AcuDC 200 meter if the communication quality is distorted.

2. Circle

AcuDC 200 meters are connected in a closed circle for the purpose of high reliability. No anti signal reflecting resistor is needed for circle mode.

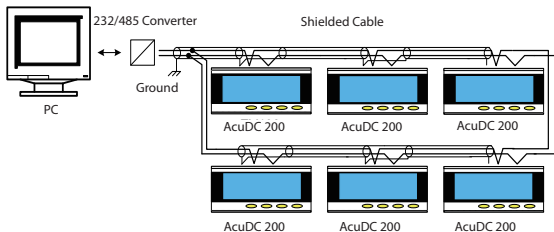

Fig 2.22 Circle mode

3. Star

When connecting AcuDC 200 meters in the Wye mode, an anti signal reflecting resistor may be needed at the end of each line for better communication quality.

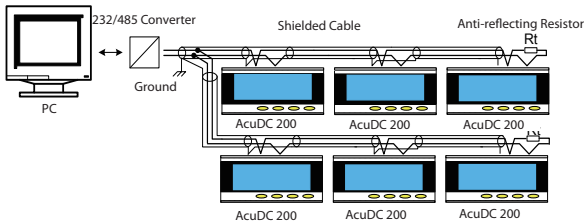

Fig 2.23 Star mode

A few points of recommendation for high quality communication are as follows:

☞ Good quality shielded twisted pair of cable AWG22 (0.6mm^2) or larger is very important.

- ☞ The shield of each segment of the RS485 cable must be connected to the ground at one end only.
- ☞ Make sure the right connection of each point.
- ☞ Avoid T connection at each point.
- ☞ Keep cables away as much as possible from sources of electrical noise. An anti signal reflecting resistor (typical value 120~300ohm/0.25W) is normally added to the end of the circuit beside the last meter if the communication quality is distorted.
- ☞ Use RS232/RS485 or USB/RS485 converter with optical isolated output and surge protection

Chapter 3 Basic Operation and Setup

3.1 Display Panel and Keys

3.2 Real-Time Metering Mode

3.3 Parameter Setting Mode

3.1 Display Panel and Keys

The front of the meter consists of a LCD display panel and four control keys. All the display segments are illustrated in fig 3.1.

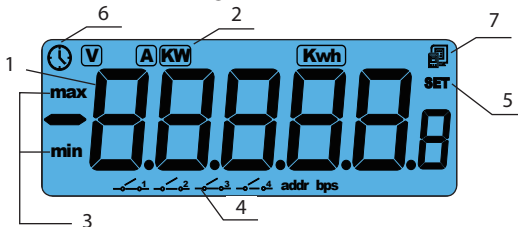



Fig 3.1 All Display Segments

Table 3.1 Display Panel Description

Numer	Display	Description
1	Data and Parameters	Display metering data in metering mode.
2	Unit Icon	Indicating metering data unit, "V" for voltage, "A" for current, "KW" for Power, "Kwh" for Energy.

3	Limit Sign	Upper/Lower limit value settings for AO.
4	Digital Input Indicator	No.1 to No.4 switches indicate status for DI1 to DI4 respectively.
5	Parameter Icon	"SET" icon and one of the following icons will be on at the same time in the setting mode. "addr" stands for device communication address setup; "bps" stands for communication rate setup; "A" stands for shunt current; "V" stands for shunt voltage. When setting up AO tracking object, "A" stands for tracking current and "V" stands for tracking voltage.
6	Time for Backlight	When "🕒" icon is on, it indicates the time set for backlight.
7	Communication Icon	When "📶" blinks, it indicates that communication is established between the meter and the master device.

Users can read real-time metering data, set parameters and navigate the meter using the four control keys: , E, P and V/A from left to right respectively. The four keys are located underneath the key cover on the meter front.

Note: This manual is written based on the AcuDC 223 (with full options) model. Some real-time metering display and parameter settings may not be available on certain models.

3.2 Real-Time Metering Mode

Depending on model, the AcuDC 200 Series meter can display real-time metering data such as voltage, current, power and energy. When the meter is powered up, the default display parameter is either voltage or current (depends on model). LCD display backlight will turn on for the preset amount of time when any one of the four keys is pressed.



Fig 3.2 Voltage Display



Fig 3.3 Current Display

Press V/A:

First screen: Voltage display page.

Voltage display: $U=220.3V$, Communication established; DI1 to DI4 are in the "OFF" state.

Second screen: Current display page.

Current display: As in fig 3.3, $I=9.487A$. DI2 and DI4 are "ON" whereas others are "OFF".

Note: Communication icon blinks when the meter is communicating with the master

device. The blinking speed is relative to the data transfer rate. The faster the icon blinks, the higher the transfer rate is.



Fig 3.4 Power display

Press P: Power display page.

The picture shows that: P=350.6KW; DI1,DI3 are close; DI2, DI4 are open. Communication established.



Fig 3.5 Energy display

Press E: Energy display page

The picture shows: E=32768.9Kwh; all DIs are open. Communication established.

Note: When the energy is greater than 99999.9Kwh, it will reset to 0 automatically.

3.3 Parameter Setting Mode

In metering mode, Press \triangleleft and V/A to go to the parameter setting mode.

Press \leftarrow to move cursor from left to right. The digit will be flashing when the cursor moves to it. Press E to increase 1 once a time. Press P to decrease 1 once a time. Press V/A to store the current setting and go to next screen. In any screen, press \leftarrow and V/A at the same time to exit the parameter setting mode.



Fig 3.6 Local address



Fig 3.7 Password input

Parameter setting mode is password protected. Before entering the password and getting into the parameter setting mode, the meter's device communication address will display for 3 seconds as shown in Fig 3.6

A four digit password (0000 to 9999) is required everytime before accessing the parameter setting mode. The default password is 0000. The meter will return to the metering mode if a wrong password is entered. Password input page shown in Fig 3.7.



Fig 3.8 Communication Address Setting

First Screen: Communication address setting. The address can be any integer between 1 and 247. As in fig 3.8, the communication address is 84. To change the address, press $\leftarrow \triangleright$ to move cursor, press P to increase the value by 1 and press E to decrease value by 1.

Press V/A to store the current address and go to the next setting screen. Press V/A to go to the next screen if there is no need to change the address.

Note: No more than two meters can have the same communication address on the same communication line according to the Modbus-RTU protocol.



Fig 3.9 Baud rate setting page

The second screen: Baud rate setting page. Modbus-RTU uses 8 data bit, no parity, 1 start bit and 1 stop bit. Baud rate can be selected from one of the five values: 1200, 2400, 4800, 9600, 19200bps. Press P or E to select a suitable baud rate. Press V/A to

go to next screen. Same baud rate should be used for all the meters on the same communication line.



Fig 3.10 Shunt current input full range setting



Fig 3.11 Shunt/Hall Effect Sensor output setting

The third screen: Shunt / Hall Effect Sensor current input full range setting. The value input is the full range current value for the Shunt or Hall Effect Sensor. AcuDC 200 series support 1~9999A shunt. The value range in this screen is 1~9999.

The fourth screen: Shunt / Hall Effect Sensor output voltage setting. The value input is the full range output voltage value for the Shunt or Hall Effect Sensor. For instance, 100mV shunt, enter 100; 5V Hall Effect Sensor, enter 50; 20mA Hall Effect Sensor, enter 20.

AcuDC 200 series support 50~100mV arbitrary voltage shunt. If it exceeds this range, the value will be reset to default 100. Our recommendation for shunt is 100mV shunt, it is better for accuracy.

The value here for shunt, the range is 50~100; for voltage Hall Effect Sensor, the range is 1~100; for current Hall Effect Sensor, the range is 4~100. 4~XmA and 0~XmA types are not exchangeable.



Fig 3.12 AO output setting

The fifth screen: AO output setting. Please refer to “Analog output” in chapter two for detail information.



Fig 3.13 AO tracking lower limit

The sixth screen: AO tracking lower limit setting page.



Fig 3.14 AO tracking upper limit

The seventh screen: AO tracking upper limit page.



Fig 3.15 Energy clear page



Fig 3.16 Back light "ON" time

time of the backlight is 5 minutes. The backlight will automatically turn "OFF" if no key activation within 5 minutes.



Fig 3.17 Voltage Hall Effect Sensor setting

The eighth screen: Energy clear page. It displays "CLE" and a digit at the same time. No change will be made if the digit is set to 0. Energy will be reset after pressing V/A if the digit is set to 1.

The ninth screen: Backlight "ON" time setting page. The LCD display backlight will turn "OFF" after inactive for a period of time to conserve energy. The "ON" time can be set from 0 to 120 minute. The backlight will always be "ON" if the setting value is 0. As in fig 3.16, the setting time of the backlight is 5 minutes. The backlight will automatically turn "OFF" if no

The tenth screen: only when the meter voltage wiring is via voltage Hall Effect Sensor, there will be this screen. Otherwise, there is no such screen. The voltage input range is 0~1200Vdc. Fig 3.17 shows the voltage input is 1000V.



Fig 3.17 Password setting

The tenth screen: Password setting page. This is the last screen in setting mode. The password can be changed in this page. It is important to remember the new password.

As in fig 3.17, the password is 0001. Press V/A to store the new password and return back to the first setting page. After finishing all of the settings, press \triangleleft and V/A keys to exit the setting mode.

Alarming

AcuDC 200 Series meter can be used for alarming. Over/under limit alarm will be triggered when the metering parameter value falls outside of the preset value limit and does not resume back to normal within the preset time delay interval. When an alarm condition is met, the alarm channel relay will be activated (switch close) and the LCD display backlight will flash. Alarm setting steps are as follows:

1. Set RO output mode to alarming (2).
2. Select alarming object. For example: voltage for AcuDC 221 (1); current for AcuDC 222 (2).
3. Set alarming delay time (0~255s)
4. Set alarming limit value.
5. Sign of inequality selection.
6. RO alarm channel selection (0: RO1; 1: RO2; 2: RO1, RO2).

Alarming parameters

Address	Parameter	Range
0105H	RO1 output mode	0-level, 1-pulse, 2-alarming
0106H	Pulse width of RO1	30~5000ms
0107H	RO2 output mode	0-level, 1-pulse, 2-alarming
0108H	Pulse width of RO2	30~5000ms
010BH	Alarming object	0: no; 1: voltage; 2: current; 3: power
010CH	Sign of inequality	0: <, 1: >

010FH 0100H	Alarming value	current: 0~9999.0 voltage: 0~600.0 power: 0~ 6000.0
010DH	Alarming delay time	0~255 s
010EH	RO alarm channel	0~RO1; 1~RO2; 2~RO1,RO2

Here is an example to show how this works

If we want to trigger an alarm at RO1 when the current is over 10.005A with a time delay of 15 seconds, we should set the alarm parameters as follows:

- 1) Set RO1 output mode to 2 (This means RO1 works under alarming mode).
- 2) Set alarming object to 2 (current). The alarming limit value should be set as 10.005.
- 3) Set alarming delay time as 15 seconds.
- 4) Set sign of inequality to 1.
- 5) Set RO alarm output channel as 0.

After setting up the alarm parameters, when the alarm condition is met (current goes above 10.005A for 15 seconds), RO1 will be activated (contact closed) and the

LCD display backlight will flash.

Note: If "RO alarm output channel" is set as 2 and RO1 is set to alarming mode, when an alarm condition is met, the alarm signal will be sent to both of the relay outputs but only RO1 will be triggered (since RO2 is not in alarming mode). If none of the relay output is set to alarming mode, no relay will be triggered.

Chapter 4 Communication and Setup

4.1 Modbus Protocol Introduction

4.2 Communication Format

4.3 AcuDC 200 Address Table

4.1 Modbus Protocol Introduction

The Modbus™ RTU protocol is used for communication in the AcuDC 200 series meter. Data format and error check methods are defined in Modbus protocol. The half duplex query and respond mode is adopted in Modbus protocol. There is only one master device in the communication net. The others are slave devices, waiting for the query of the master. Only the master device can communicate with slave devices. The slave devices cannot communicate with each other. They can only response to the query of master device.

1. Transmission mode

The mode of transmission defines the data structure within a frame and the rules used to transmit data. The mode is defined in the following which is compatible with Modbus RTU Mode*.

① Coding System	8bit	④ Parity	None
② Start bit	1bit	⑤ Stop bit	1bit
③ Data bits	8bit	⑥ Error checking	CRC

2. Protocol

Framing

Table 4.1 Data Framing

Address	Function	Data	Check
8-Bits	8-Bits	N x 8-Bits	16-Bits

Address Field

The address field of a message frame contains eight bits. Valid slave device addresses are in the range of 1~247 decimal. A master addresses a slave by placing the slave address in the address field of the message. When the slave sends its response, it places its own address in this address field of the response to let the master know which slave is responding.

Function Field

The function code field of a message frame contains eight bits. Valid codes are in the range of 1~255 decimal. When a message is sent from a master to a slave device the function code field tells the slave what kind of action to perform.

Table 4.2 Function Code

Code	Meaning	Action
01	Read Relay Output	Obtain current status of Relay Output
02	Read Digital Input	Obtain current status of Digital Input
03	Read Registers	Obtain current binary value from one or more registers
05	Control Relay Output	Force relay state to "ON" or "OFF"
16	Preset Multiple-Registers	Place specific binary values into a series of consecutive Multiple-Registers

Data Field

The data field is constructed using sets of two hexadecimal digits, in the range of 00 to FF hexadecimal. The data field of messages sent from a master to slave devices contains additional information which the slave must use to take the action defined by the function code. This can include items like discrete and register addresses, the quantity of items to be handled, and the count of actual data bytes in the field.

Check Field

Check field is used in the master and slave device to find errors in the data transmitting. Inaccuracy may occur within a data group due to noise or other

interference when being transitted from one device to another. The check field guarantees the device does not respond to error messages in order to improve system reliability and efficiency. CRC16 error check method is adopted in Modbus Protocol.

3. Error Check Method

Every message includes an error checking field which is based on the Cyclical Redundancy Check (CRC) method. The CRC field checks the contents of the entire message. It is applied regardless of any parity check method used for the individual characters of the message. The CRC field is two bytes long, containing a 16-bit binary value. The CRC value is calculated by the transmitting device, and is appended to the message. The receiving device recalculates the CRC value during reception of the message, and compares the calculated value to the actual value it received in the CRC field. If the two values are not equal, an error will be reported. CRC calculation is first started by preloading the whole 16-bit register to 1's. The process begins by applying successive 8-bit bytes of the message to the current contents of the register. Only the eight bits of data in each character are

used for generating the CRC. Start and stop bits, and the parity bit, do not apply to the CRC. When generating the CRC, each 8-bit character is exclusive ORed with the register contents. The result is shifted towards the least significant bit (LSB), with a zero filled into the most significant bit (MSB) position. The LSB is extracted and examined, if the LSB equals to 1, the register is exclusive ORed with a preset, fixed value; if the LSB equals to 0, no action will be taken. This process is repeated until eight shifts have been performed. After the last (eighth) shift, the next 8-bit byte is exclusive ORed with the register's current value, and the process repeats for eight more shifts as described above. The final contents of the register, after all the bytes of the message have been applied, the final contents of the register, which should exchange the high-byte and the low-byte, is the CRC value. When the CRC is appended to the message, the low-order byte is appended first, followed by the high-order byte.

4.2 Communication Format

All examples shown in this chapter follows the same format of Table 4.3. (All data is express in Hex)

Table 4.3 Protocol Format

Addr	Fun	Data start reg HI	Data start reg LO	Data #of regs HI	Data #of regs LO	CRC16 HI	CRC16 LO
11H	03H	01H	00H	00H	08H	47H	60H

The meaning of each abbreviated word is,

Addr: Address of slave device

Fun: Function code

Data start reg HI: Start register address high byte

Data start reg LO: Start register address low byte

Data #of reg HI: Number of register high byte

Data #of reg LO: Number of register low byte

CRC16 HI: CRC high byte

CRC16 LO: CRC low byte

1. Read Status of Relay (Function Code 01)

Query

This function code is used to read status of relay in the meter.

1=On 0=Off

There are 2 relays in the meter. The address of each relay is:

Relay1=0000H and Relay2=0001H.

The following query is to read the relay status for the meter with communication address 17.

Table 4.4 Read the status of Relay1 and Relay2 Query Message

Addr	Fun	DO start reg HI	DO start reg LO	DO #of regs HI	DO #of regs LO	CRC16 HI	CRC16 LO
11H	01H	00H	00H	00H	02H	BFH	5BH

Response

The meter response includes the meter address, function code, quantity of data byte, the data, and error checking. An example response to read the status of Relay1 and Relay2 bits is shown as Table 4.5. The status of Relay1 and Relay2 is

responding to the last 2 bits of the data. Relay1: bit0 Relay2: bit1

Table 4.5 Relay status responds

Addr	Fun	Byte count	Data	CRC16 HI	CRC16 LO
11H	01H	01H	02H	D4H	89H

The content of the data is,

7	6	5	4	3	2	1	0
0	0	0	0	0	0	1	0

MSB

LSB

(Relay 1 = OFF , Relay 2=ON)

2. Read Status of DI (Function Code 02)

Query

1=On 0=Off

There are 4 DIs in the meter. The address of each DI is DI1=0000H, DI2=0001H, DI3=0002H and DI4=0003H. The following query is to read the 4 DI status of the meter with communication address 17.

Table 4.6 Read the status of DI1~DI4 Query Message

Addr	Fun	DI start addr HI	DI start addr LO	DI num HI	DI num LO	CRC16 HI	CRC16 LO
11H	02H	00H	00H	00H	04H	7BH	59H

Response

The AcuDC 200 response includes the AcuDC 200 address, function code, quantity of data characters, the data characters, and error checking. An example response to read the status of 4 DIs is shown in Table 4.7. The DI status corresponds to the last 4 bits of the data. DI1: bit0 DI2: bit1 DI3: bit2 DI4: bit3

Table 4.7 Read Status of DI

Addr	Fun	Byte count	Data0	CRC16 HI	CRC16 LO
11H	02H	01H	03H	E5H	49H

Data

7	6	5	4	3	2	1	0
0	0	0	0	0	0	1	1

MSB

LSB

3. Read Data (Function Code 03)

Query

This function allows the master to obtain the measurement results from the meter. Table 4.8 is an example to read the measured data from slave device number 1, the data address for voltage V is 0200H.

Table 4.8 Read V Query Message

Addr	Fun	Data start addr HI	Data start Addr LO	Data # of regs HI	Data # of regs LO	CRC16 HI	CRC16 LO
01H	03H	02H	00H	00H	01H	85H	B2H

Response

The meter response includes the meter address, function code, quantity of data byte, data, and error checking. An example response to read V=0001H (0.01V) is shown in Table 4.9.

Table 4.9 Read V Message

Addr	Fun	Byte count	Data HI	Data LO	CRC16 HI	CRC16 LO
01H	03H	02H	00H	01H	79H	84H

4. Control Relay (Function Code 05)

Query

This message forces a relay to either turn "ON" or "OFF". Any relay that exists within the meter can be forced to either "ON" or "OFF" status. Relay addresses start at 0000H (Relay1=0000H Relay2=0001H). The data value FF00H will set the relay on and the value 0000H will turn it off; all other values are illegal and will not affect that relay. The example below is a request to the meter number 1 to turn on Relay1.

Table 4.10 Control Relay Query Message

Addr	Fun	DO addr HI	DO addr LO	Value HI	Value LO	CRC16 HI	CRC16 LO
01H	05H	00H	00H	FFH	00H	8CH	3AH

Response

The normal response to the command request is to retransmit the message as received after the relay status has been altered.

Table 4.11 Control Relay Response Message

Addr	Fun	Do addr HI	Do addr LO	Value HI	Value LO	CRC16 HI	CRC16 LO
01H	05H	00H	00H	FFH	00H	8CH	3AH

5. Preset / Reset Multi-Register (Function Code 16)

Query

Function 16 allows the user to modify the contents of a multi-register. Any register that exists within the meter can have its contents changed by this message. The example below is a request to meter number 1 to preset alarming value(1000), alarming delay(4s), and alarming output to RO1.

Table 4.12 Preset / Reset Multi-Register Message

Addr	Fun	Data start reg HI	Data start reg LO	Data # of reg HI	Data # of reg LO	Byte Count	
01H	10H	01H	0BH	00H	03H	06H	

Value1 HI	Value1 LO	Value2 HI	Value2 LO	Value3 HI	Value3 LO	CRC HI	CRC LO
07H	D0H	00H	05H	00H	01H	82H	3DH

Response

The normal response to a preset multi-register request includes the slave address, function code, data start register, the number of registers and error checking.

Table 4.13 Preset Multi-Registers Response Message

Addr	Fun	Data start reg HI	Data start reg LO	Data #of reg HI	Data #of reg LO	CRC16 HI	CRC16 LO
01H	10H	01H	0B H	00H	03H	F0H	36H

4.3 AcuDC 200 Address Table

Metering data is stored in these register areas. Use Modbus function code 03 to read metering data.

Table 4.14 Metering data address table

Address	Parameter	Range	Object Type	Type of Access
0200H,0201H	Voltage V		Float	R
0202H,0203H	Current I		Float	R
0204H,0205H	AO output		Float	R
0206H,0207H	Power		Float	R

The relationship between the numerical value in the register of AcuDC 200 and the real physical value is shown in table below. (Rx is the numerical value in register of the meter)

Table 4.15 Metering data convert table

Parameter	Relationship	unit
Voltage V	Real =Rx	V
Current I	Real =Rx	A
Power	Real =Rx	kW
Energy	Real =Rx/100	kWh
AO output	Real =Rx	V or mA (related with AO pattern)

Parameter Setting

Function code: 03 for Reading, 16 for Presetting

Table 4.16 System parameter address

Address	Parameter	Range	Object Type	Type of Access
0100H	Access Code	0~9999	Word	R/W
0101H	Address	1~247	Word	R/W
0102H	Baud rate	1200~19200	Word	R/W
0103H	Shunt full range current input	0~9999(A): input range of Shunt / Hall Effect Sensor	Word	R/W
0104H	Shunt full range output voltage	0: No shunt/HCT; 1~100: Full range output of shunt / hall effect sensor	Word	R/W
0105H	RO1 output mode	0-level, 1-pulse, 2-alarming	Word	R/W

0106H	Pulse width of RO1	30~5000ms	Word	R/W
0107H	RO2 output mode	0-level, 1-pulse, 2-alarming	Word	R/W
0108H	Pulse width of RO2	30~5000ms	Word	R/W
0109H	AO output	0: no; 1: voltage; 2: current; 3: power	Word	R/W
010AH	Backlight "ON" time	0~120minute	Word	R/W
010BH	Alarming object	0: no; 1: voltage; 2: current 3: power		
010CH	Sign of inequality	0: <, 1: >	Word	R/W
010DH	Alarming delay time	0~255 s	Word	R/W
010EH	RO alarm channel	0~RO1; 1~RO2; 2~RO1,RO2	Word	R/W
010FH, 0110H	Alarming value	The same as reading data	Float	R/W
0111H, 0112H	Lower limit of AO	The same as reading data	Float	R/W
0113H, 0114H	Upper limit of AO	The same as reading data	Float	R/W
0115H, 0116H	Energy presetting	0~9999999	Long	R/W
0117H	Voltage Hall Effect Sensor Input	0~1200V	Word	R/W
0118H	Voltage Hall Effect Sensor Output	1~5V	Word	R/W

Please refer to chapter 3 for more information.

Digital Input (DI) Status:

Function code: 02 for Reading

Table 4.17 Digital Input (DI) Address

Address	Parameter	Range	Object Type	Type of Access
0000H	DI1	1=ON, 0=OFF	Bit	R
0001H	DI2	1=ON, 0=OFF	Bit	R
0002H	DI3	1=ON, 0=OFF	Bit	R
0003H	DI4	1=ON, 0=OFF	Bit	R

Relay Status and Control

Function code: 01 for Reading, 05 for Controlling.

Table 4.18 Relay Address

Address	Parameter	Range	Object Type	Type of Access
0000H	DO1	1=ON, 0=OFF	Bit	R/W
0001H	DO2	1=ON, 0=OFF	Bit	R/W

Analog output:

Function code: 03 for Reading, 16 for Presetting.

Table 4.19 AO Address

Address	Parameter	Range	Object Type	Type of Access
0109H	Transform object	0~2	Word	R/W

Note:

1. Object type: Bit-binary bit, Word-unsigned integer of 16 bit, Integer-signed integer of 16 bit, Dword-unsigned integer of 32 bit.
2. Type of access: R-Read only; Relay Output (RO) status, Digital Input (DI) status and general measurement parameters can be read from memory using function code 01, 02 and 03 respectively. R/W - Read and Write; data can be read from and written into memory using function code 16. Control command can be written using function code 05. Writing to "Read only" field is forbidden.

Appendix

Appendix A Technical Data and Specifications

Appendix B Ordering Information

Appendix C Hall Effect Sensor Specifications

Appendix D Revision Information

Appendix A Technical Data and Specifications

1. Measurement

Parameter	Accuracy	Resolution	Range
Voltage	0.2%	0.01V	0~600V
Current	0.2%	0.005A	0.005~9999A
Power	0.5%	0.01W	0.01~6,000,000W
Energy	0.5%	0.1kWh	0.1~99999.9kWh

2. Communication

Parameter	Description
Type	RS485, Half Duplex, Optical isolated
Baud Rate	1200~19200bps
Protocol	Modbus-RTU
Isolate Voltage	2500Vac
Function	Read and Write setting parameters
	Read measuring data
	Execute operation instruction

3. Output

Relay Output (RO)	
Output Form	Mechanical Contact, Form A
Max Load Voltage	250Vac/30Vdc
Max Load Current	3A
Contact Resistance	100mΩ(Max)
Isolate Voltage	4000Vac
Contact Material	silver alloy
Mechanical Endurance	5×10 ⁶ cycles
Output Form	latching or pulse (30 to 5000ms) or alarming
Analog output (AO)	
Range	4~20mA or 0~5V
Resolution	12bit
Load Capability	4~20 mA, 0~5 V
Max Resistance	500Ω
Max Current	20mA

4. Input

Current	
Current	0~10A(Direct Input), 0~9999A(Extra current shunt or HCT, with programmable range)
Shunt	50~100mV(Programmable)
Hall Current Thruster (HCT)	0~5V, 0~4V, 0~20mA, 4~20mA
Power Consumption	2W(Max)
Accuracy	0.2%
Voltage	
Input Voltage	0~600V
Input Impedence	2M Ω
Load	< 0.2W
Digital Input (DI)	
Isolate Voltage	2500Vac rms
Input Type	Wet contact (Contact with power supply)
Input Resistance	2K ohm (typical)
Input Voltage Range	16~30Vdc
Max Input Current	20mA

5. Environment

Parameter		Description
Humidity		0~95% Non-condensing
Temperature		-25°C~70°C
Package	Size	165mm×70mm×115mm
	Weight	0.4Kg

6. Power Supply

Parameter		Description
Input	Option 1	100~240Vac, 50/60Hz; 100~300Vdc
	Option 2	20~60 Vdc
Power Consumption		2W

Appendix B Ordering Information

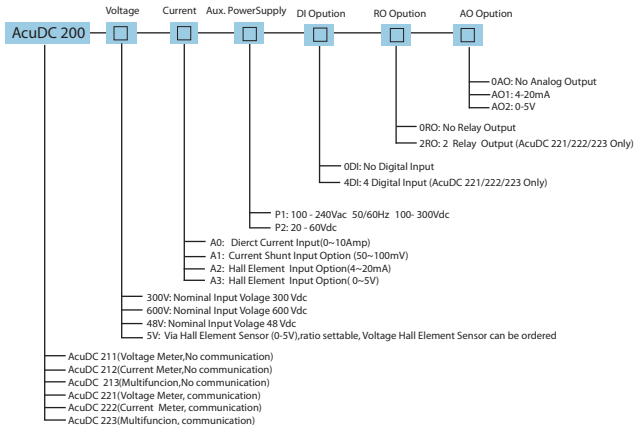

AcuDC Series Meter Ordering Example: AcuDC 223 - 300V - A2 - P1 - 4DI- 2RO- AO1

Voltage Hall Effect Sensor Ordering Information

Special order

Please contact your local Accuenergy

Representative for further details

Current Hall Effect Sensor Ordering Information

Special order

Please contact your local Accuenergy

Representative for further details

Note:

1. When the input voltage is above 600V, or the system design requires an isolation, the voltage input can be selected as Via Hall Effect Sensor (0-5 V). The Voltage Hall Effect Sensor requires 0-5 V.
2. Hall Effect Sensors need external $\pm 15\text{Vdc}$ power supply, which the customer must provide.

Appendix C Revision Information

Revision	Date	Description
1.0	20080215	First version
1.02	20090305	Add content at P36 and P60 ; Add HCT content in this manual
1.03	20090610	Revise content
1.20	20100422	Revise content
1.21	20100830	Change the address of Energy parameter
1.22	20120727	Update the wiring diagram Update the method for generating CRC value Remove hall effect sensor ordering information and specifications



Accuenergy Corporation

Los Angeles-Toronto-Beijing

North America Toll Free: 1-877-721-8908

Web: www.accuenergy.com

Email: marketing@accuenergy.com